

Data Sheet

Thumbwheel Switch Multiswitch, Series B

- Compact design
- Discretionary configuration and subdivision of switching modules
- Switch for front mounting
- Simple assembly
- Precise reading of the set values

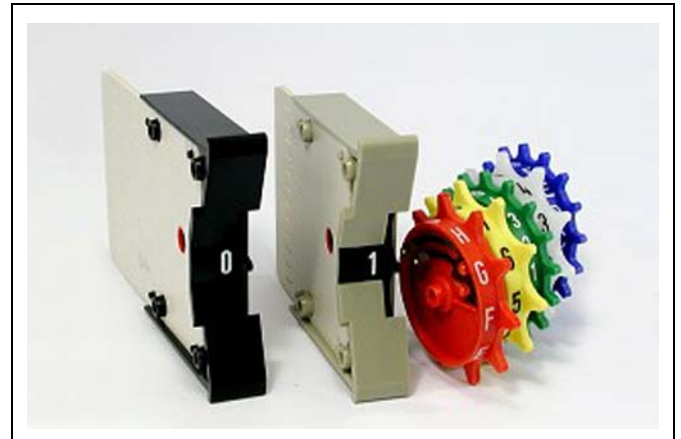

Technical Data

Rated current (resistive load)	1-100 mA AC/DC
Max. current carrying capacity	1 A AC/DC
Max. working voltage	42 V AC/DC
Test voltage	500 V DC
Insulation resistance (+20°C)	10 ⁵ MΩ
Contact resistance typical	100 mΩ
Service life (switch operations)	min. 10 ⁶
Permissible ambient temperature	-25° ... +70°C
10 positions	Yes
16 positions	Yes
Decimal	Yes
Binary coded decimals (BCD)	Yes
BCD and complement	Yes
BCD negative	Yes
Solder pins	Yes
Wire wrap pins	Yes
PCB for diode mounting	Yes
Direct solder connections	Yes
Edge connections	Yes
Front mounting	Yes
Ganged switches	Yes
Illuminated thumbwheel	Optional

Dimensions

Width	12.5 mm
Height	58 mm
Mounting depth switch + S0	67.1 mm
Mounting depth switch + LS	82.1 mm
Character height	4 mm

Side view

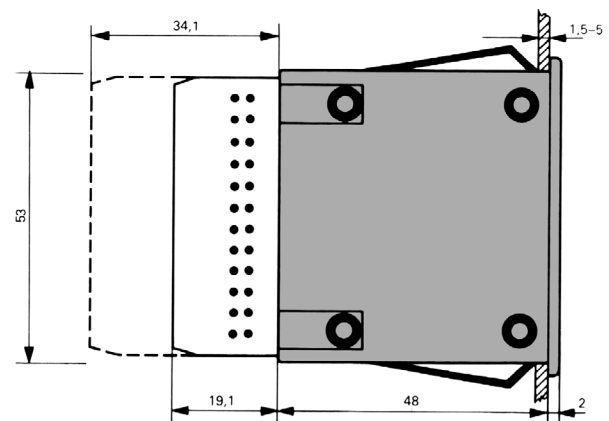

Front view

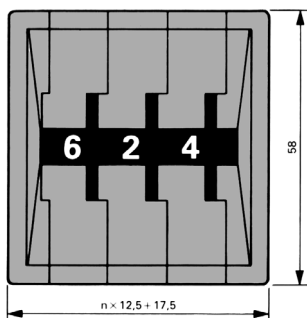

Panel cut-out

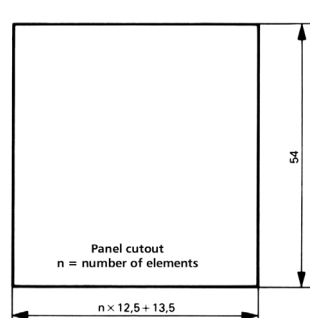

Top view

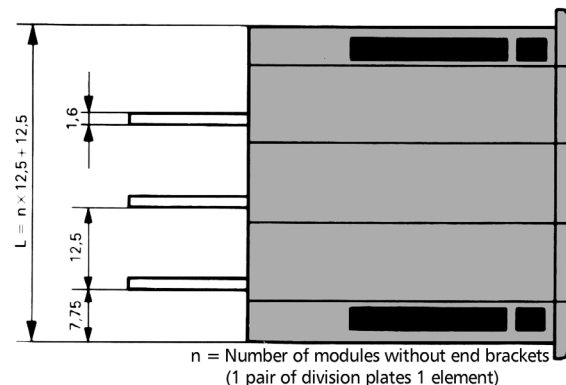

PCB design

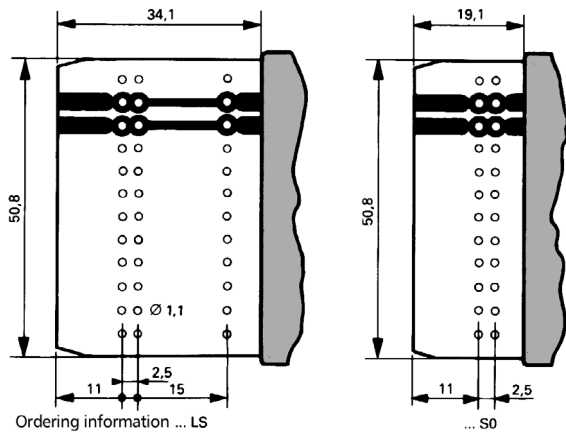

Division plates and end brackets

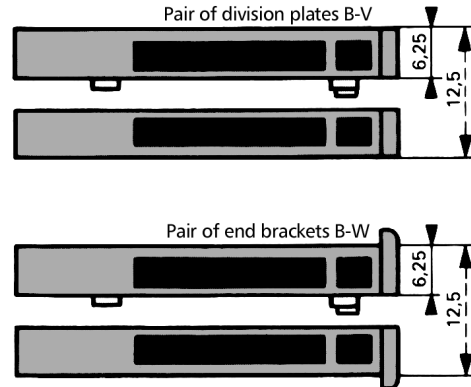

Standard codes

Description	Code
Two pole change-over switch	001
Decimal 0-9	010
Decimal 0-10	011
Decimal 0-16	016
BCD positive + complement	031
Aiken positive + complement	033

Description	Code
BCD positive + complement, make before break contacts	044
BCD + 2 inputs	140
BCD + 2 inputs, 16 positions	239
Single pole change-over switch	701
BCD positive	731
BCD negative	861

Ordering Data

① Series		B
② Color of housing	gray black	A B
③ Coding	refer to table (3 digits)	
④ Execution of circuit board	short board with solder and plug in connections long board with solder and plug in connections fitted with diodes (anode connector side) fitted with diodes (cathode connector side) with interrupted circuits	S0 LS LA LK LU
⑤ Marking of selector disk	Standard 0 – 9 Standard 0 – 15 Marking 0 – 9 A – F Marking according to customer's requirement	- - F M
⑥ Color of selector disk	black green yellow red blue opal (illuminated)	0 1 2 3 4 8

⑦ Terminals	Pin connector Solder pins Wire wrap pins	- S W
⑧ Optional	Limit stops i. e. switching range 3 to 6	A... A36

Order key

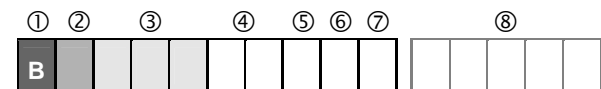

- ① Series
- ② Color of housing
- ③ Coding
- ④ Execution of circuit board
- ⑤ Marking of selector disk
- ⑥ Color of selector disk
- ⑦ Terminals
- ⑧ Optional

Specifications are subject to change without notice.

Truth tables and connections

Code 001
Two pole change-over switch

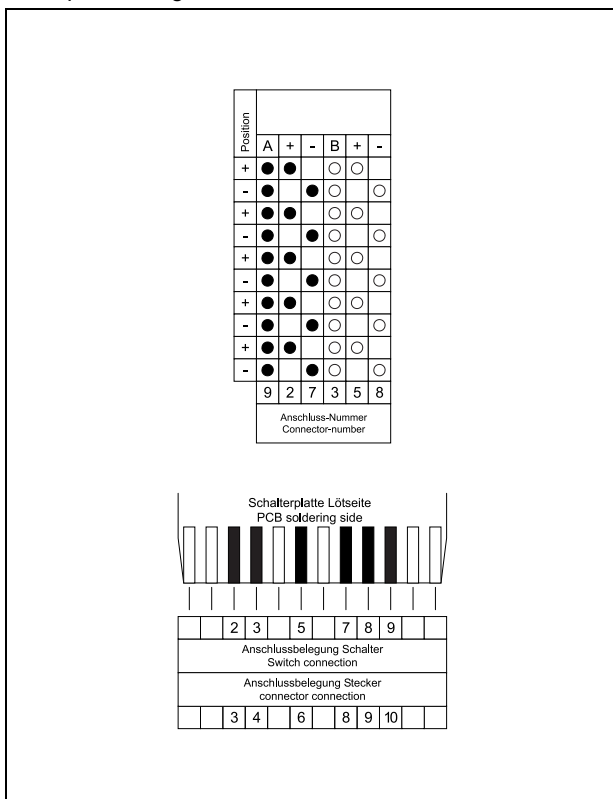

Code 010
Decimal 0-9

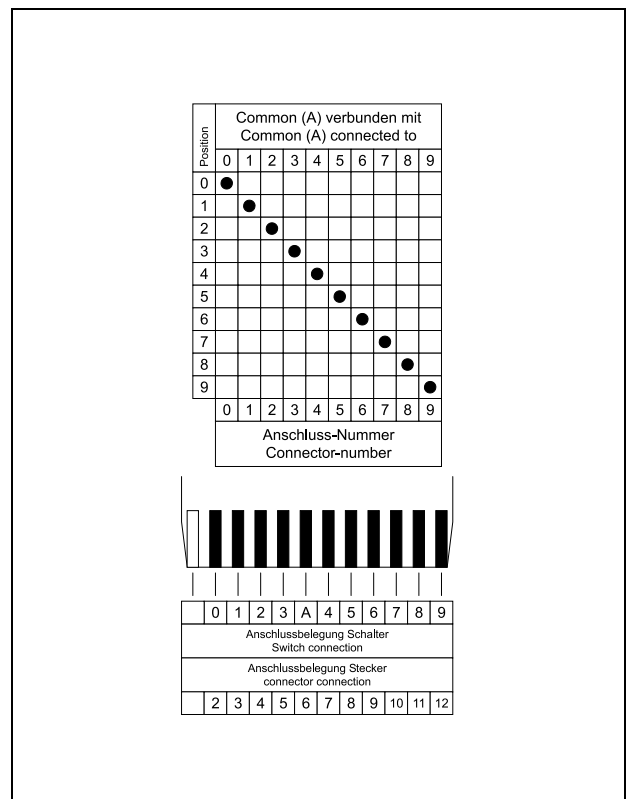

Code 011
Decimal 0-10

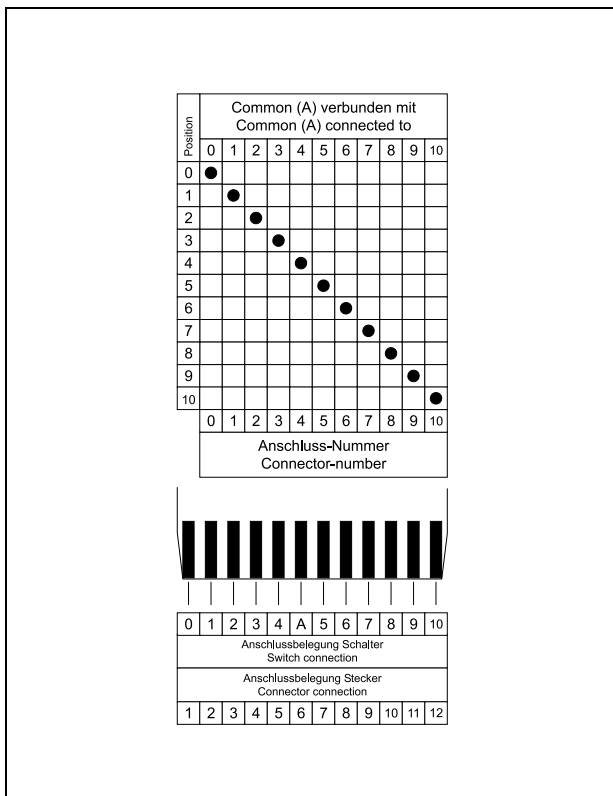

Code 016
Decimal 0-15

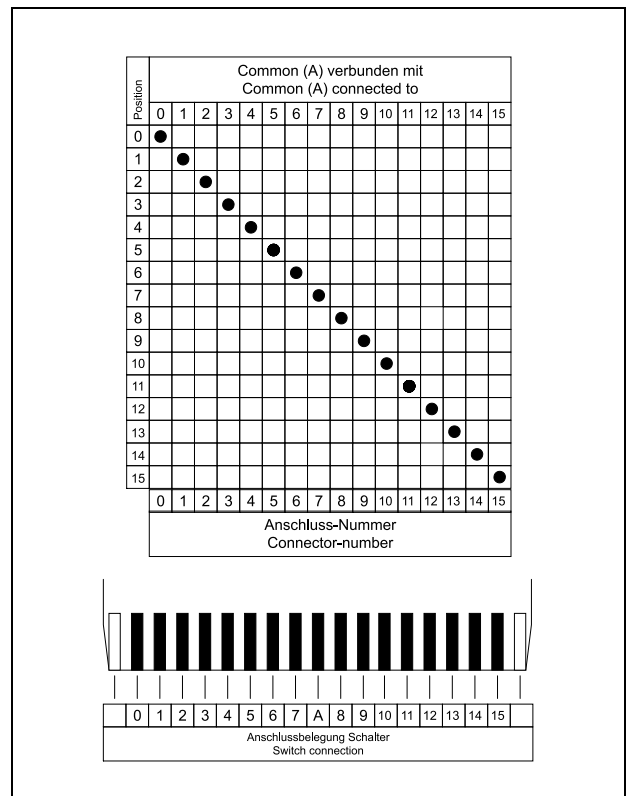

Truth tables and connections

Code 031
BCD positive + complement

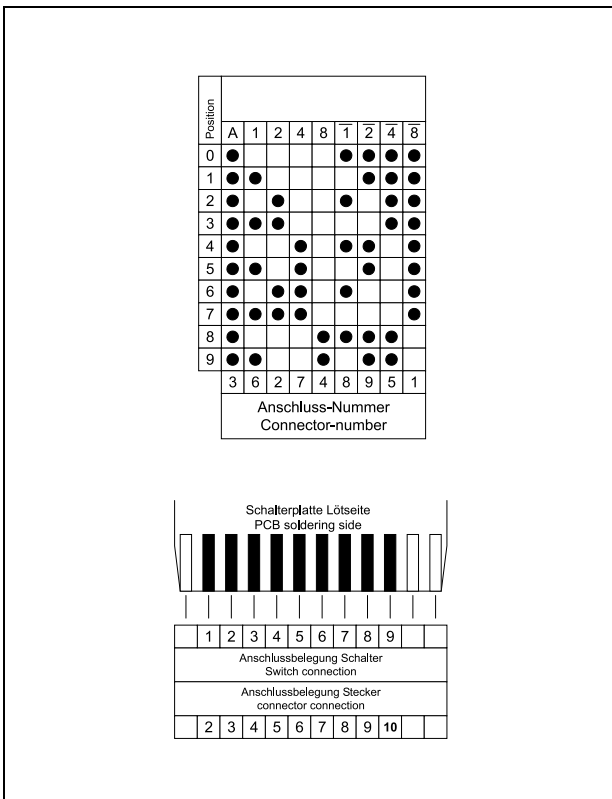

Code 033
Aiken positive + complement

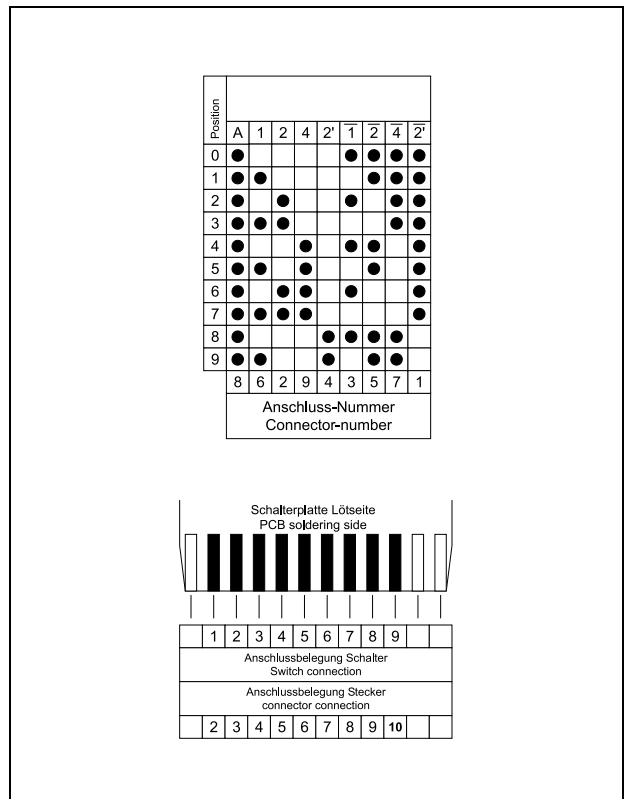

Code 044
BCD positive + complement - make before break contacts

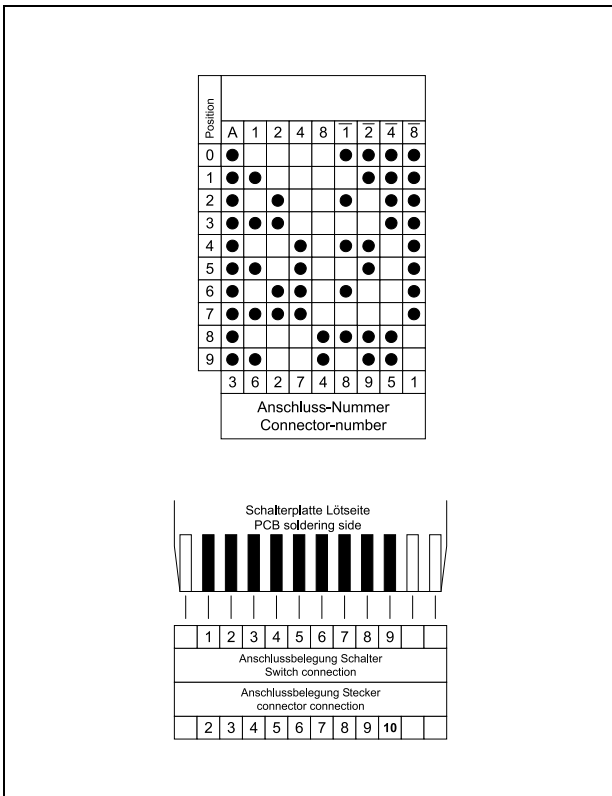

Code 140
BCD + 2 inputs

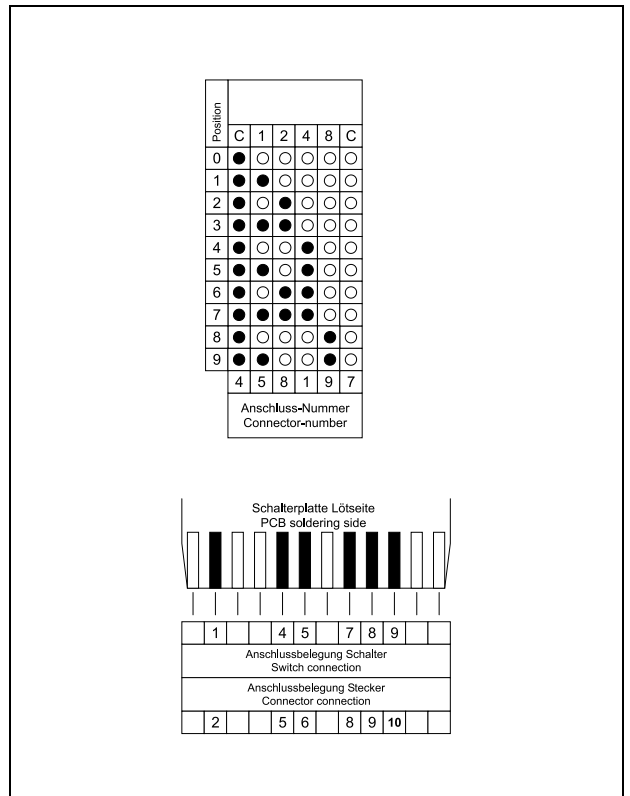

Truth tables and connections

Code 239
BCD + 2 inputs - 16 positions

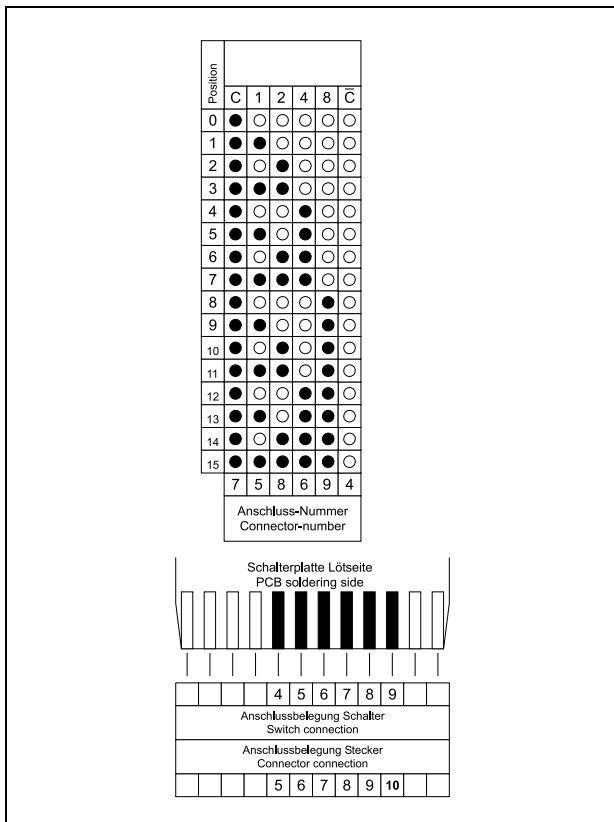

Code 701
Single pole change-over switch

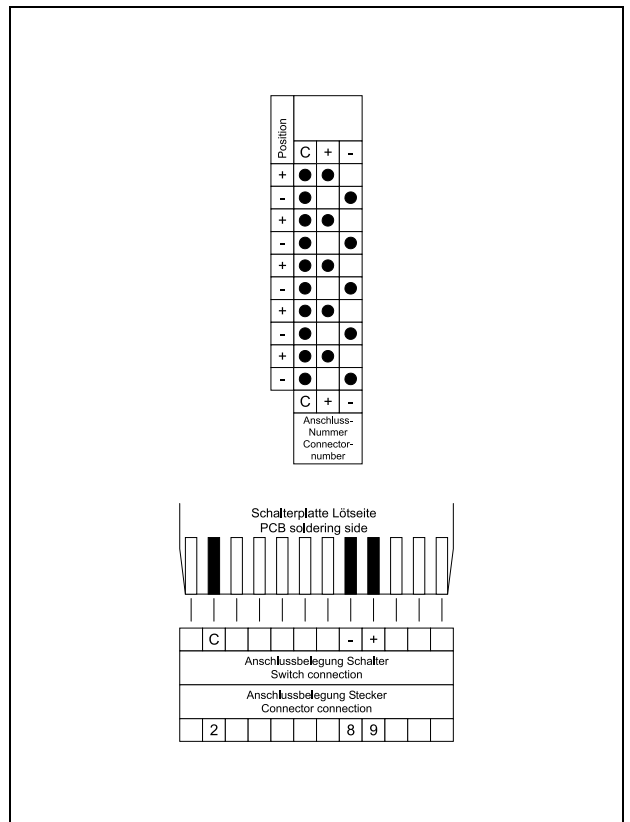

Code 731
BCD positive

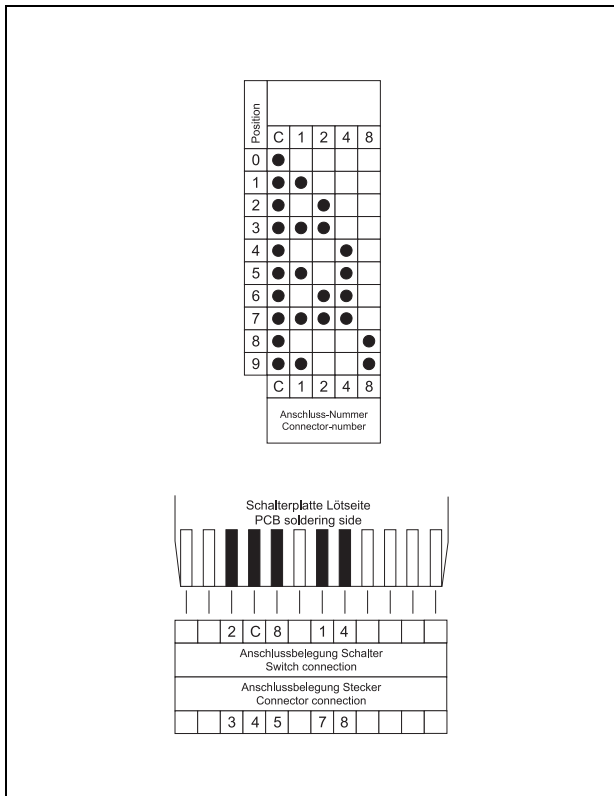

Code 861
BCD negative

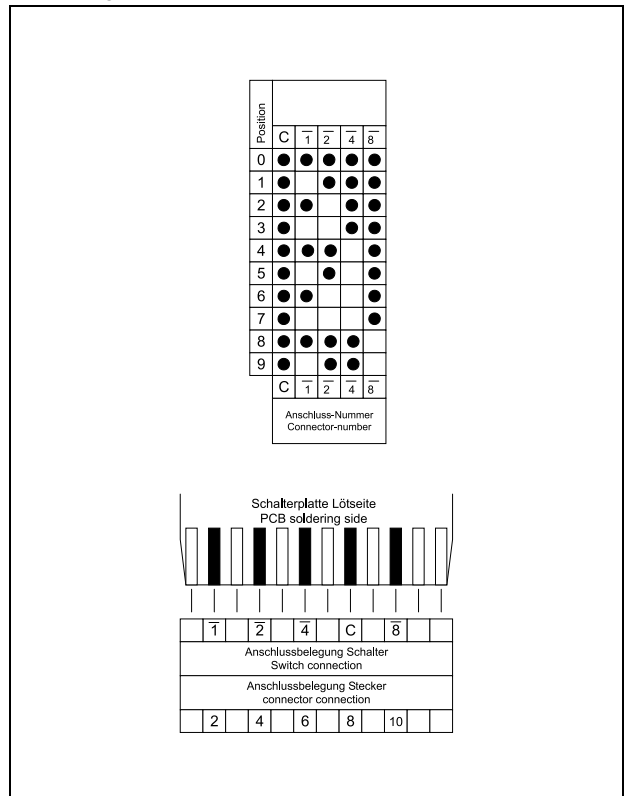

General

Advanced industrial process automation and measurement systems often require the input of data from an Operator. With simple systems of small complexity this is normally the input of a number or code. Multiswitch, the family of thumbwheel switches from Crameda, are the ideal device for this purpose. The design principle is that of a step switch but deviates from conventional switches in that the switch shaft is not perpendicular but parallel to the front panel.

Multiswitch thumbwheel switches are used in machine tool control systems, measurement and test units, control and regulation systems, sound and vision control systems, medical measurement systems, etc. The essential features of the thumb-wheel switch are its high reliability, precision and contact en-durance. Many years of experience with diverse applications has resulted in a comprehensive range of products with an extremely high level of component quality.

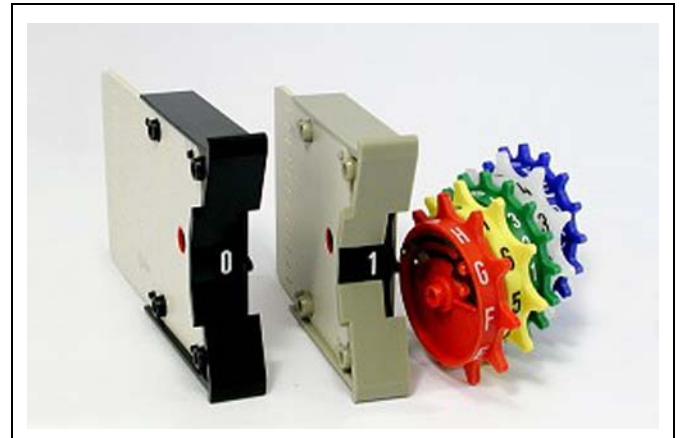

Customised products and accessories

Special marking of selector disk

In place of characters, letters, icons or symbols can be printed on request.



Colors of selector disk

Multiswitches are standard with a black thumbwheel and white characters.

Upon request, the thumbwheels can be delivered in green, red or blue with white characters. In yellow and in opal with black characters.



Marking on the housing

Markings, i.e. words, special characters or symbols are possible and need to be specified in detail (drawing).

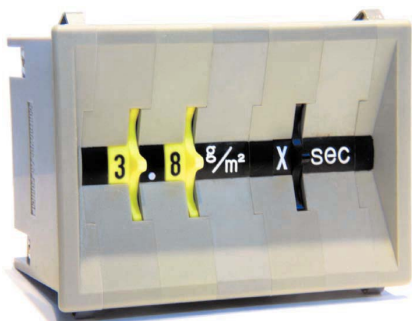

Switch with illuminated thumbwheel

Multiswitches of series A, B, H, M and P are available with a translucent thumbwheel. The housing is provided with a rectangular cut-out to accommodate a light source to be provided by the user. The light beam is routed through the translucent thumbwheel to the front of the switch.

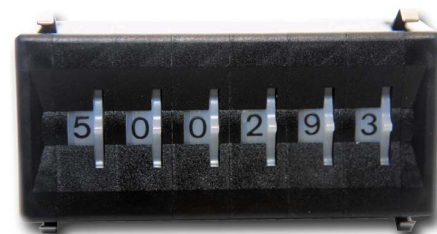

Terminals

Multiswitches are equipped with pin connections as standard. Alternatives are: solder pins or wire wrap pins.

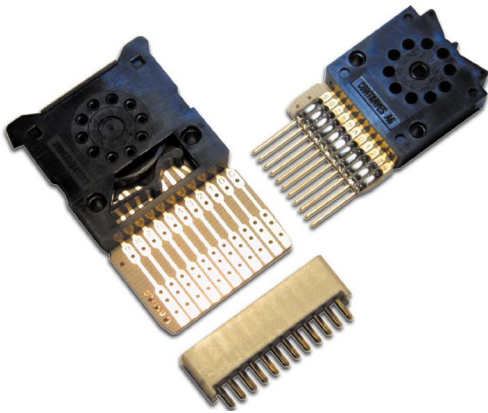

Dummy switches

Dummy switches appearance is identical to the standard switches. However, the dummy switch has no contacts or printed circuits inside. It can be useful in satisfying aesthetic layout requirements.

Dummy switches are not available for series D or Z.



Limit stops

Upon request, all Multiswitches, except series D and Z, can be provided with limit stops.

The stop pins (model series H, L, M, S, U, V, W) can be set from outside by the user.

The stops (series A, B, G, P, Q, R and, H and M 16 positions) are set during assembly and cannot be changed later.

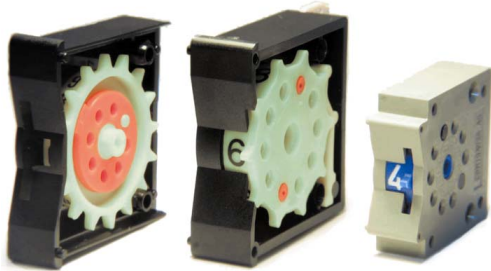

Blank spacing module

A blank spacing module has the same dimensions as the corresponding Multiswitch.

It can be placed in any position within the switch assembly, allowing desired subdivisions.

Blank spacing modules are not available for series R.

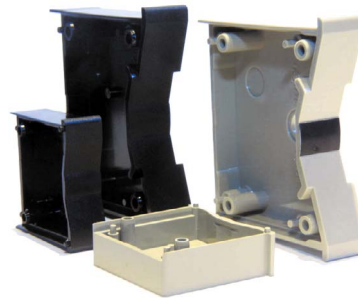

Coupled switches

Blind slave switches have the same technical specification as standard switches, but have no thumbwheel and are closed at the front. Each blind slave switch is equipped with a coupling element. They are coupled to a Multiswitch of identical size on the left or right hand side.

Please note: Blind slave switches are available in series A, B, G, H, L, M, P and V.

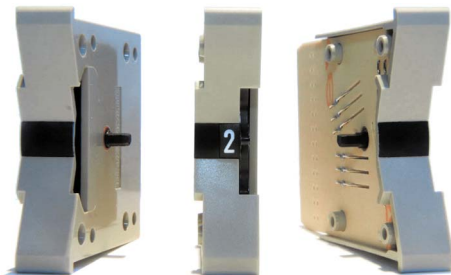

Distance plate

A distance plate is half as wide as a corresponding Multiswitch. It can be placed in any position within the block assembly, allowing desired subdivisions.

Distance plates are available in series D, H, and P.

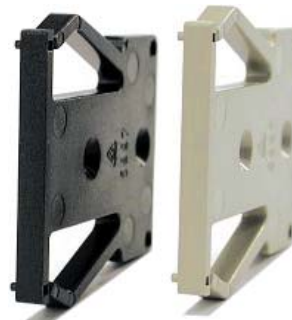

Division module

A switch assembly may contain several switch groups separated by ribbed division modules. The dimensions of a division module correspond to those of a switch module.

Division modules are available in series A, L, M, Q, U, V and W.

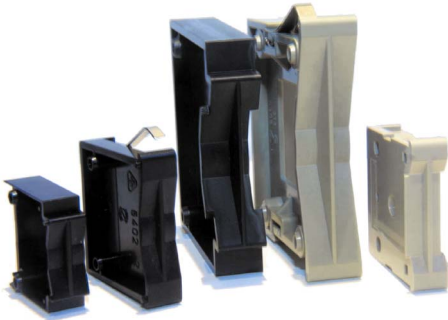

Pair of division plates

For assembling Codicounts (7-Segment LED displays) and Multiswitches, division plates can be used to stack displays and switches together.



End brackets and block assembly

The individual switch module can be arranged into block assemblies. These are complemented by two end brackets and held together with threaded rods.

The assembly is inserted into the rectangular cut-out of the front panel.

Switch series for front mounting are secured by retaining springs.

Switch types for rear mounting are inserted into the front panel cut-out from behind and secured by four screws.

Based on customer specification, Crameda provides block assembly of switches as a "ready to install" service.

In series D, U, V and Z, mounting brackets are added left and right, pressed together lightly, yielding a ready to install block.

For more detailed information please refer to End brackets, mounting accessories and block assembly.

